

4 ELEVATION
Scale: 3/4" = 1'-0"

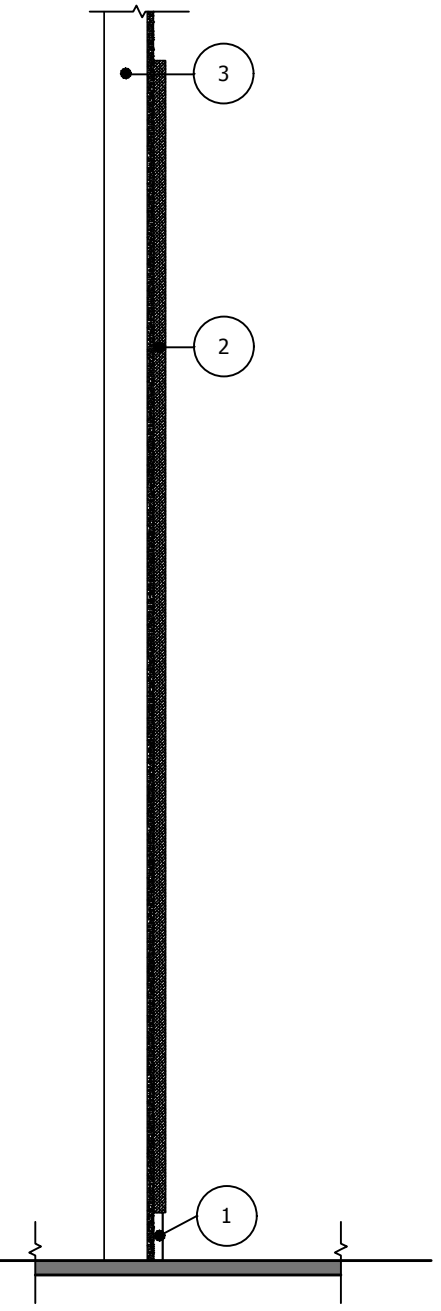

3 SECTION
Scale: 3/4" = 1'-0"

- KEY
- 1 BASEBOARD BY OTHERS
 - 2 POSHFELT® PANEL
 - 3 EXISTING WALL ASSEMBLY

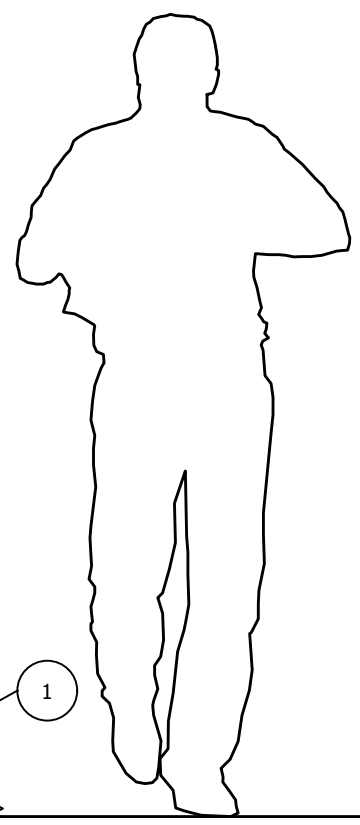
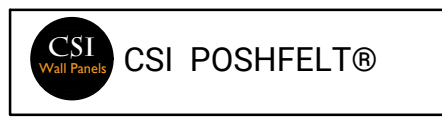
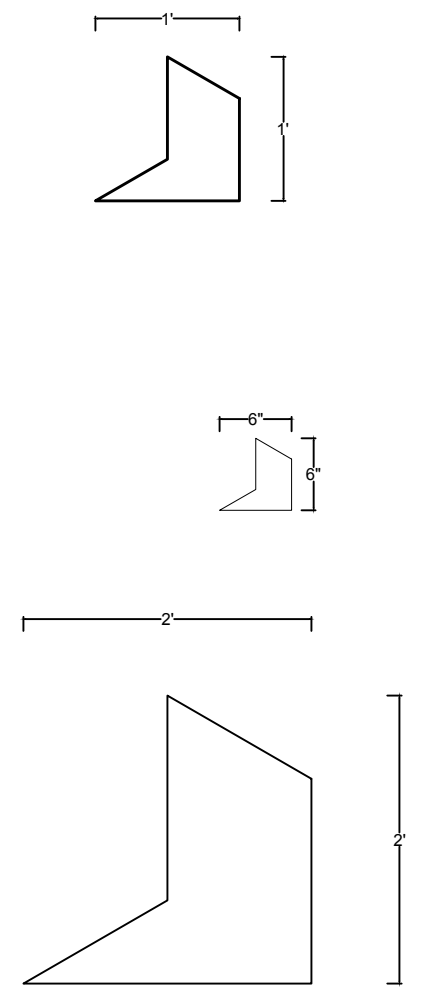

PROJECT POSHFELT® PLANAR
 ADDRESS:
 COMM. #: 24.10.18
 DATE: 24.10.18
 REVISED:
 DRAWN: MK CHECKED: PC

ID#PFCPLA2755
 CSI PANEL LAYOUT
 SCALE: SCALED FOR 11x17
 NOTE:

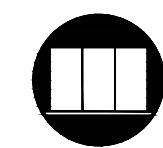
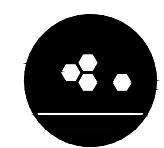

SHEET
 1.1
 OF 1.1