

4 ELEVATION  
Scale: 3/4" = 1'-0"

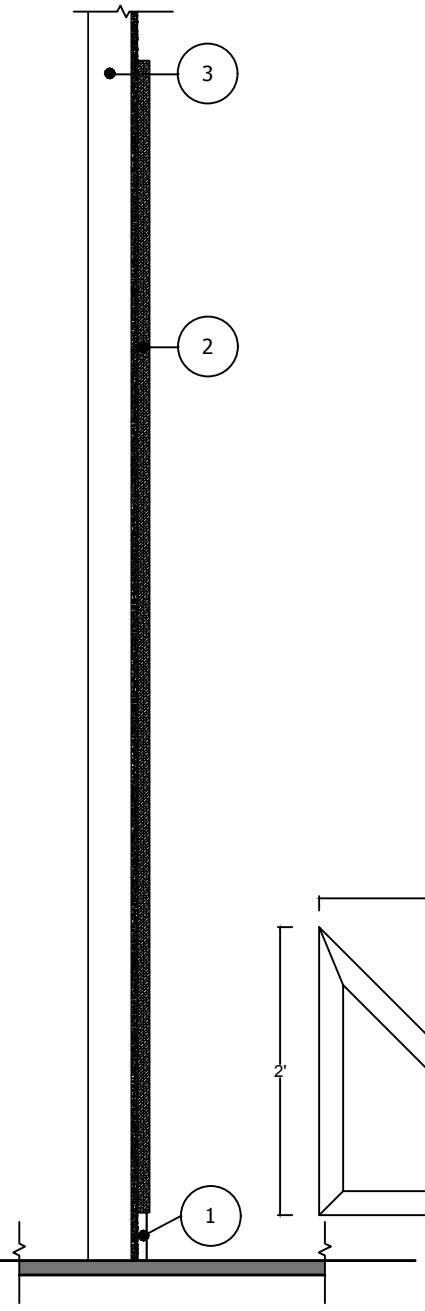
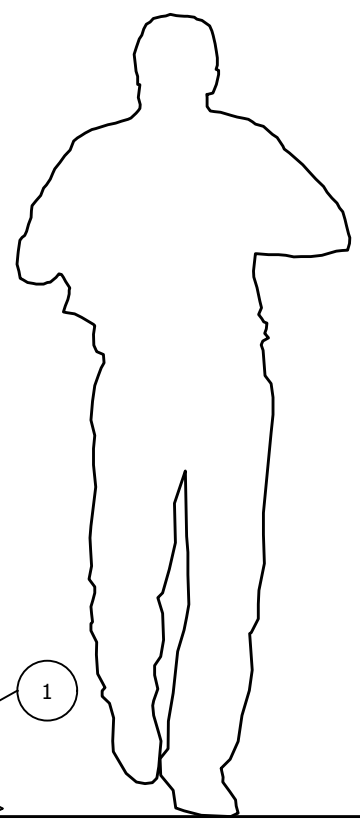

3 SECTION  
Scale: 3/4" = 1'-0"

KEY

- 1 BASEBOARD BY OTHERS
- 2 POSHFELT® PANEL
- 3 EXISTING WALL ASSEMBLY

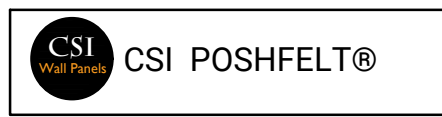
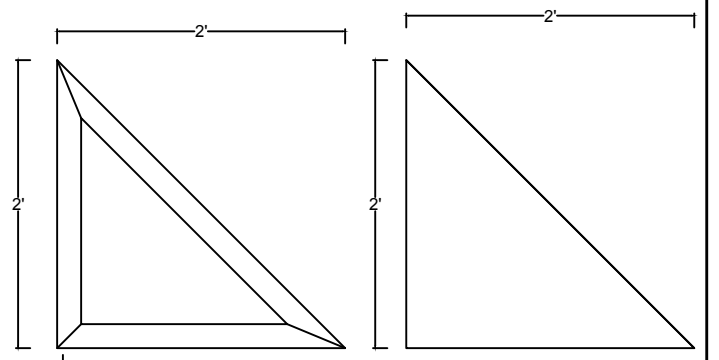
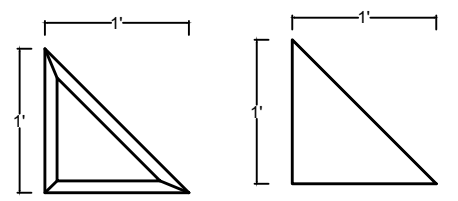
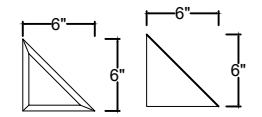

PROJECT POSHFELT® PLANAR  
 ADDRESS:  
 COMM. #:   
 DATE: 24.10.18  
 REVISED:  
 DRAWN: MK CHECKED: PC

ID#PFCPLA2739  
 CSI PANEL LAYOUT  
 SCALE: SCALED FOR 11x17  
 NOTE:

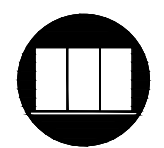
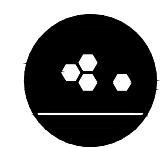

SHEET  
 1.1  
 OF 1.1